

Overhead-Braced, Floor-Mounted Partitions

Compact Laminate - Solid Phenolic Core

General Information

The most popular style of partition recommended for heavy traffic or vandalism-prone areas. Attached to the floor and stabilized at the top of the pilaster using an anti-grip headrail. Made of 1/2" thick compact laminate, high-pressure decorative surface with matte finish, and black phenolic-core material. The edges are black and finished smooth. Equipped with stainless-steel hardware and vandal-resistant Torx screws.

With privacy and aesthetics in mind, all our doors and pilasters have a built-in feature that eliminates sight lines into the stalls. Our Flush finish, automatic-close door hinge, and occupancy indicator latch make our partitions the best choice for any restroom area.

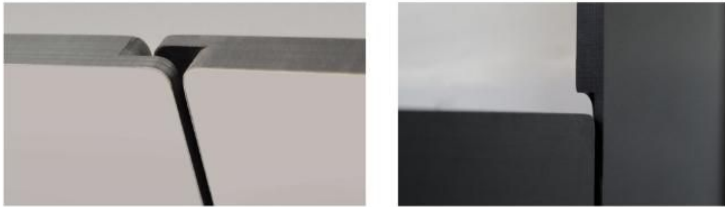

Solid Phenolic Core

1/2" thick compact laminate panels, made from layers of recycled paper fibers dipped in resin stacked and sandwiched between laminate. Later compressed under high pressure and heat to be permanently melded together. Material is characterized by its aesthetic qualities, durability, and functional performance. It is resistant to wear, impact, scratching, moisture, and heat, and possess good hygienic and anti-static properties. They are easy to clean, and maintain, and are perfect for high-traffic areas. The material will not delaminate even under extreme conditions.

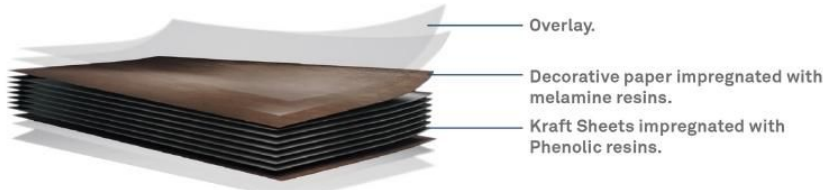

Panels, doors, and Pilasters

Constructed from 1/2" thick compact laminate. Hinged pilasters come with factory-made perforations for attaching the hinges easily.

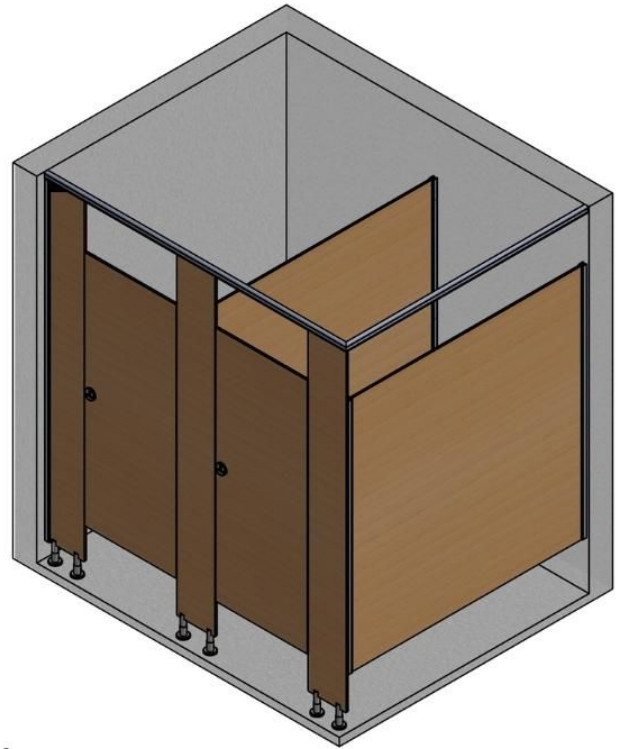

Hardware

Our partitions are offered in a variety of sizes and are installed using a continuous aluminum bracket to hang them to the wall. Accompanied with stainless-steel Torx screws, automatic-close door hinges, and occupancy indicator slide latch. They are provided with all the hardware and fastenings needed to offer a complete installation. Brackets, door hinges, and latches are guaranteed for life.



All doors are provided with a combination coat hook/bumper.

San Diego, CA 92103

Variations

Overhead-Braced or Floor-Mounted

Rubicon Lux

Integrating overhead illuminated occupancy signal, allowing users inside and outside the stall to know if the stall is occupied. Using the same headrails, we have been able to update our partitions and provide the users with a better experience.



The door latch includes an electromagnetic mechanism that activates the occupancy signal of the stall.

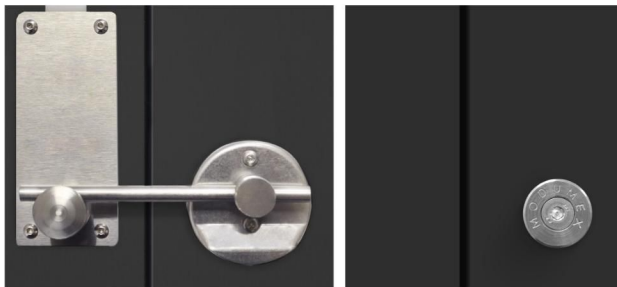

For Rubicon LUX a power outlet must be available and ready to use for every 6 stalls, prior to installation; Rubicon S2 needs a power outlet for every 3 stalls. A no-break must always be in place to protect the system from power surges.

If a power outage occurs, both systems will continue to work for 10-15 minutes after. Then, the lights will turn off and the doors will remain operational. Regarding the lock systems, the S2 systems is operated with power so it will stop locking the door. For the LUX system, the doors can continue to be locked since the latch operates without electricity.

Rubicon S2

Allowing a touchless experience in toilet partitions, S2 integrates a touch-free latch that enables the user to lock and open the door without touching surfaces.

Complemented with a proprietary foot pedal, specially made for toilet partitions, which allows easy access to the stall.



In addition to the touchless experience, our pilasters come with LED occupancy indicator lights.

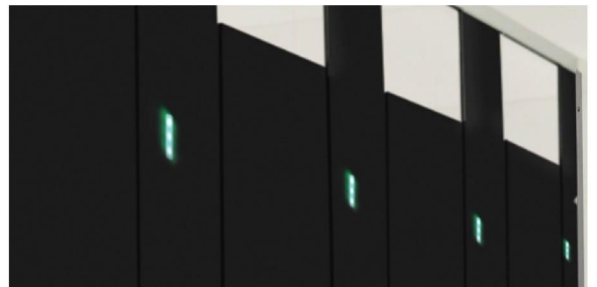

San Diego, CA 92103

Consider panels and door sizes, as well as stall dimensions to effectively comply with ADA requirements
Verify all rough-in dimensions prior to installation.

Consult local and national codes, compliance to local and national codes is the responsibility of the installer.
This information is subject to change without notice.

Brackets and Headrail

Continuous anodized aluminum U-bracket provided for panels and pilasters to be hung together and to the wall. Our brackets ensure stability even in high-traffic areas.

Anodized aluminum with polished finish headrail with an anti-grip profile. It clamps over the pilaster and secures at the wall.



Foot Pedestals

Height-adjustable stainless-steel foot pedestal attaches to pilasters and anchors to the floor with a metallic wedged anchor. The pedestal is made of a 1 - 1/8" in diameter, 303 type stainless steel bar and comes with a stainless steel 304 type cover and footrest to protect anchors and give an aesthetic look.



Maintenance and care

Our partitions shall be cleaned with water and soap and dried with a cloth. It is necessary to grease hinges and tighten screws every three months.

Avoid the use of muriatic acid and bleach or products that may contain it. Do not clean using abrasive fibers or products.

For grease, paint, graffiti or permanent marker stains, clean with solvent to remove stains, then proceed to rinse with water and soap.

Standard Colors*

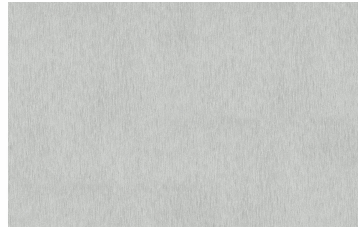

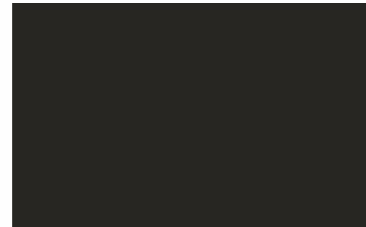

Satin Stainless



Black

**Standard color delivery time ranges between 2-5 business days. A wider variety of colors is available upon request and may require longer delivery times.*

| Available Sizes | Widths |
|------------------------|------------------------------------------------------------------------------------------------------------------------------------------------------------------|
| Panels - 58" tall | 12, 14, 16, 18, 20, 22, 24, 26, 28, 38, 40, 42, 44, 46, 48, 50, 54, 60, 72  |
| Pilasters - 78" tall | 4, 5, 6, 7, 8, 10, 12, 14, 16, 18, 20, 22, 24, 34, 36, 40, 48 |
| Doors - 58" & 67" tall | 22, 24, 26, 28, 30, 32, 34, 36, 40  |

San Diego, CA 92103

Consider panels and door sizes, as well as stall dimensions to effectively comply with ADA requirements
 Verify all rough-in dimensions prior to installation.
 Consult local and national codes, compliance to local and national codes is the responsibility of the installer.
 This information is subject to change without notice.

Example of Overhead-Braced Partition arrangement

